



A papermodel by

TECHNOMANIA MODELS



Instruction TRON Recognizer

In general:

- 1.) Cut the parts in the middle of the red outside lines, groove (from behind) and fold them in the middle of the red inside ones. The white areas are glueing points between subassemblies (note the **grey** partnumbers which show you which part has to be glued to this location). Repair possible cracks in the folded edges with matching red color (e.g. jelly-pen or pastel-chalk) at the end. Use transparent drying paper glue **sparingly**. Choose by yourself if you prefer to glue edge-to-edge or if you create a little gluing-tongue while cutting the parts.
- 2.) Before you fold or glue take a look at the drawing - sometimes a picture says more than thousand words...
- 3.) The following sequence is only a suggestion, only a few parts are really glued together at the end so you can change it if you like.
- 4.) How to connect parts which aren't really connected?
Well, some ideas how to do it are at the end of this instruction..



In detail:

- 1.) Cut part 1 two times, fold each to a cube and glue.
- 2.) Cut part 2 two times, fold each to a cube and glue.
- 3.) Cut part 3 two times, fold the sideparts (with the triangular „foot“) 90°, fold the long middle-part following the contour and glue the closed „legs“.
- 4.) Cut part 4, fold the narrow side-parts 90°, fold the big parts following the contour and glue. The sloping part is the front, the shorter part is below, the longer one up.
- 5.) Cut part 5, lengthwise fold the two sides with the sloping edge and the big side 90° each and glue. Fold the two small rectangular sides along the contour of the other ones and glue. The straight sides are front and rear, the sloping ones left and right. The bigger side is up, the smaller one down.
- 6.) Cut part 5, lengthwise fold the two sides with the sloping edge and the big side 90° each and glue. Fold the two small rectangular sides along the contour of the other ones and glue. The straight sides are left, right and rear, the sloping one is the front. The bigger side is up, the smaller one down.
- 7.) Cut parts 7a and 8a, fold all sides 90° and glue. The shorter black sides are inside, the longer ones outside.
- 8.) Cut parts 7b and 8b (cut also at the mark in the middle, so that you get 2 separate parts). Fold all sides following the contour of the neighbouring ones and glue. Glue together part 7a and 7b as well as 8a and 8b, the straight sides are rear.
- 9.) Cut part 10, fold all sides following the contours of the neighbouring ones and glue. The straight side is rear, the biggest one is up, the smaller one down.
- 10.) Cut part 9 - **do not fold or glue!** Cut out the two small areas marked with „9c“. Cut out part 9c two times, fold all sides 90° and glue. **Let dry!** Glue the two parts 9c in the openings of part 9. **Let dry!** Now fold all sides following the contour of the neighbouring ones and glue. Cut part 9b, fold it and glue it into the fitting opening of part 9. The straight side is rear. **Let dry!**

Continued on page 2

Instruction TRON Recognizer, page 2

11.) Cut parts 11, 12, 13 and 14. Fold all sides following the contours of the neighbouring ones and glue. Let **dry!** The straight sides are rear. The yellow side of part 13 is the cockpit and therefore it shows to the front. Glue the parts together following the markings. This is the „head“ of the recognizer.

All parts are finished yet. Now all parts must be connected with gaps (which measurements are listed below) between the parts as you can see in the screenshots. This is the really interesting part, like i wrote in the introduction: How to connect parts which aren't connected? Well, as unobtrusive as possible! Here a few ideas:

- 1.) Use clear styrene or acrylic rods to cut small spaceholders and glue them in the middle between the pieces.
- 2.) Use thin but stable wire and create spaceholders as mentioned before under point 1 - this variant is relatively unstable, but the cheapest one.
- 3.) Glue all parts with the matching space between them on a clear styrene or acrylic plate (the rear of the recognizer is completely flat, so mounting is no problem). Doing that you get a nice „Flight-Display“-effect. This is the most exact and stable variant, but also the most expensive one!

At least the measurements for the gaps. Mentioned are the gaps between the parts with the corresponding numbers. You can also use the provided mounting template which is in 1:1 scale:

- 1 + 2:2 mm, place part 2 in the middle of part 1
- 1 + 4:4 mm
- 1 + 7a:4 mm
- 1 + 8a:4 mm
- 3 + 4:4 mm
- 4 + 5:1 mm
- 4 + 6:1 mm
- 7b + 8b:5 mm
- 7b / 8b + 6:1 mm
- 7b / 8b + 10:2 mm
- 11-14:0 mm (glue together, see instruction)
- 7b / 8b + 9 / 9b: ..2 mm
- 9 / 9b + 11-14:0.8 mm

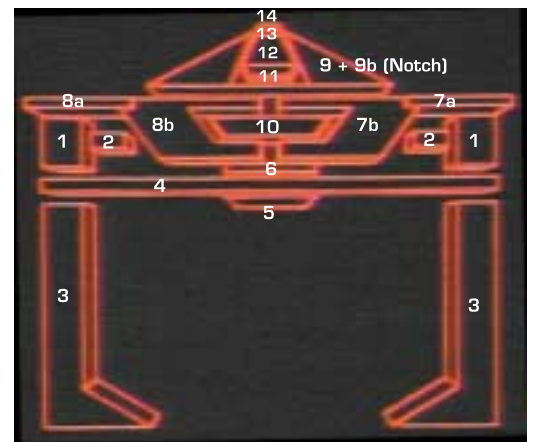

Happy modeling!

© 2003 Technomania Models



Mounting template

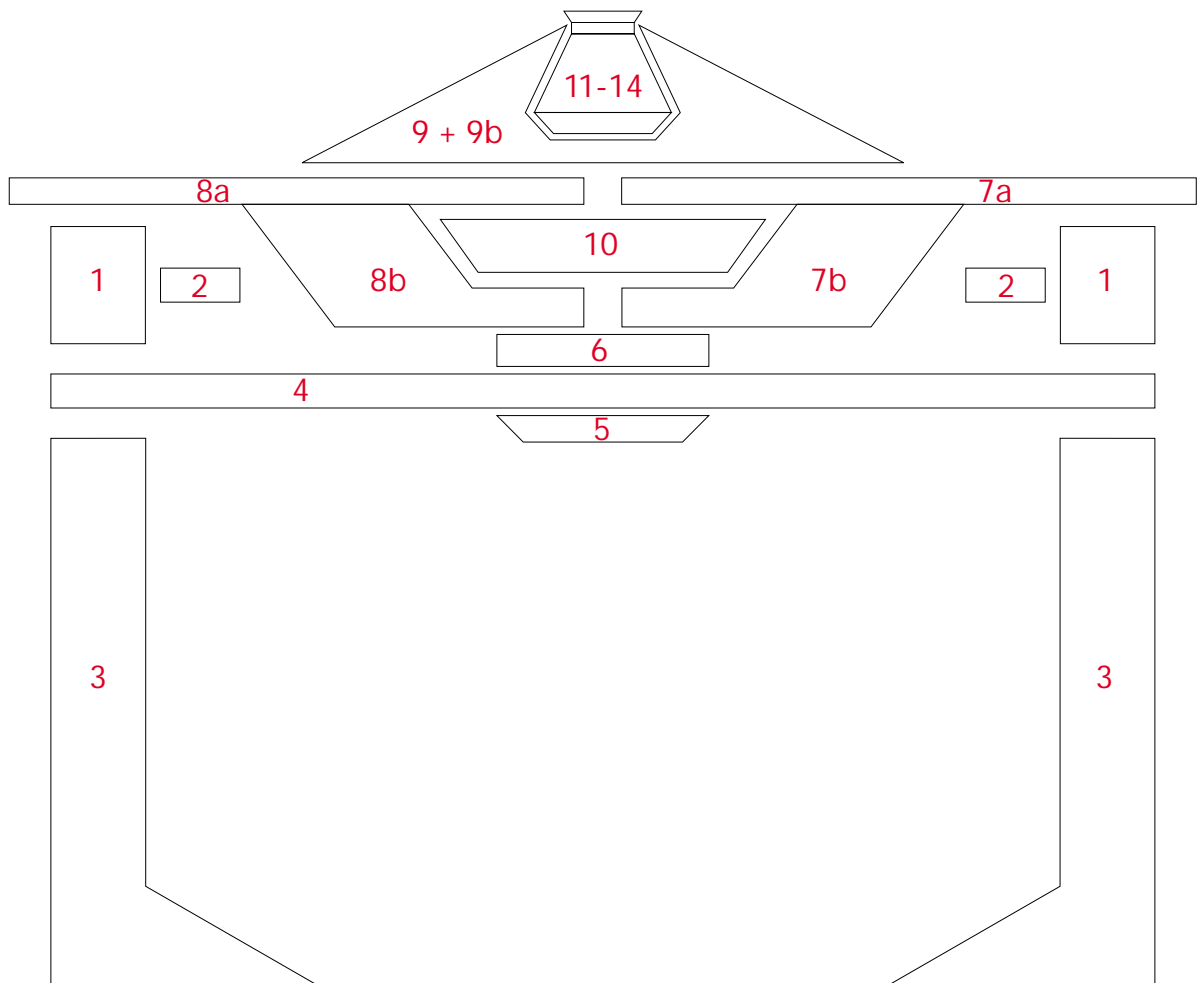

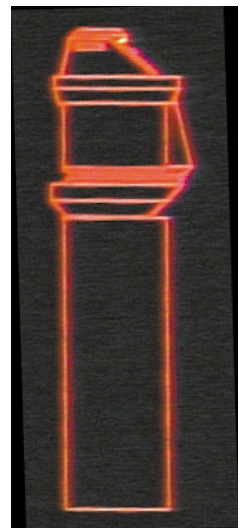
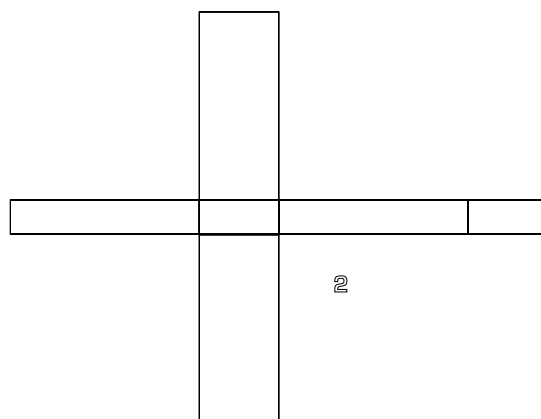
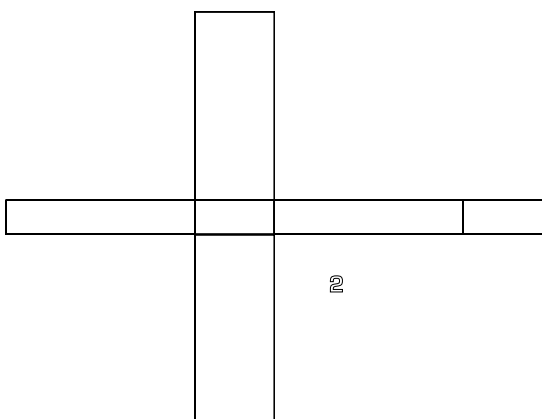
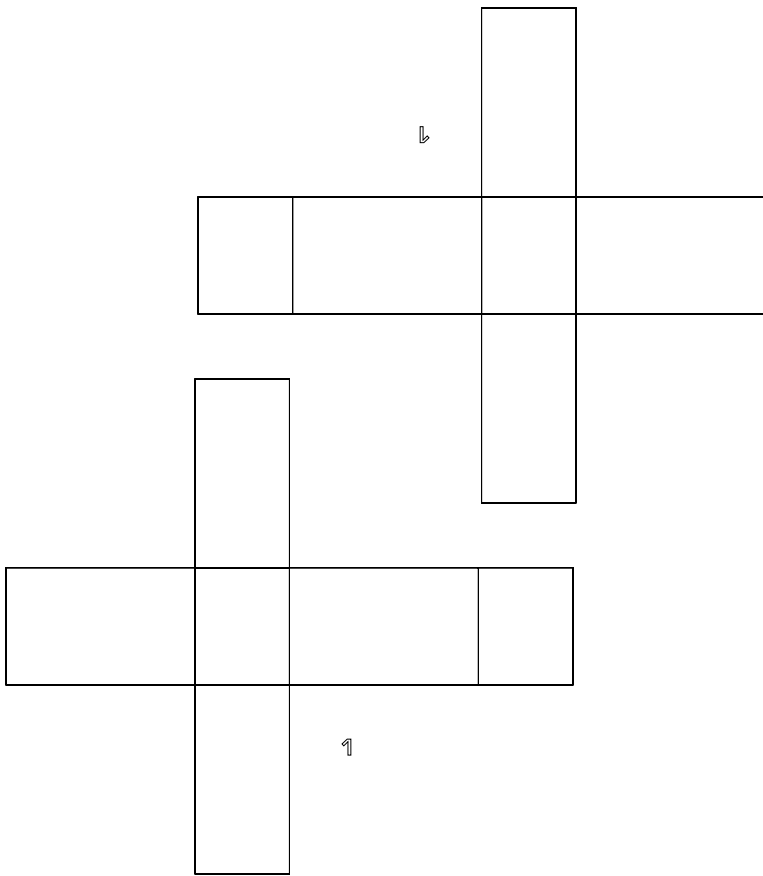
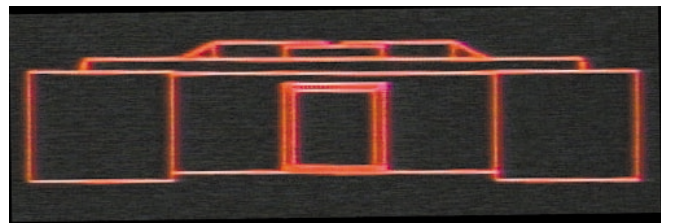
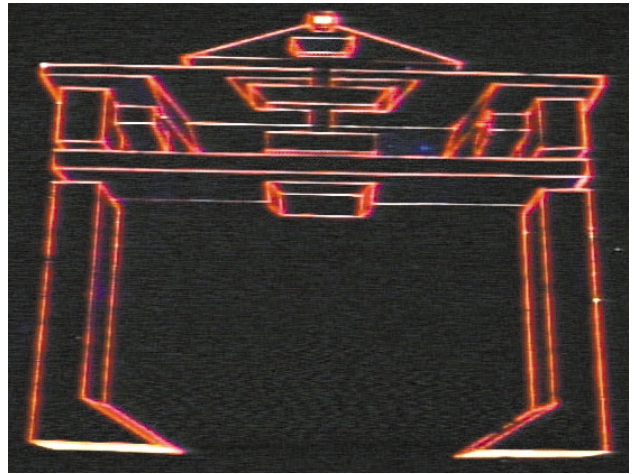
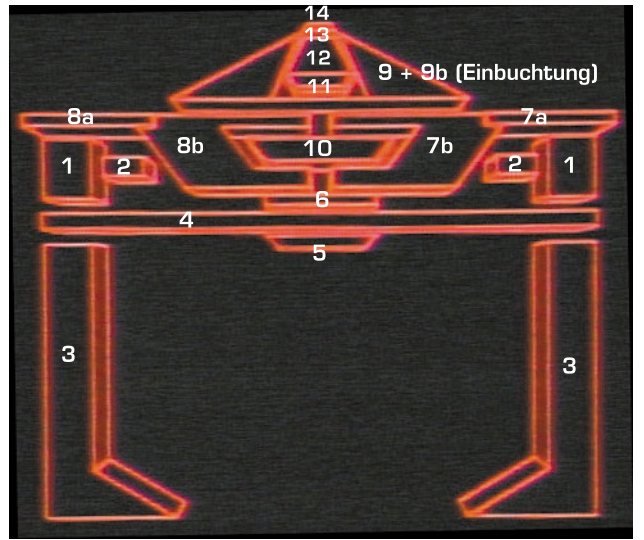
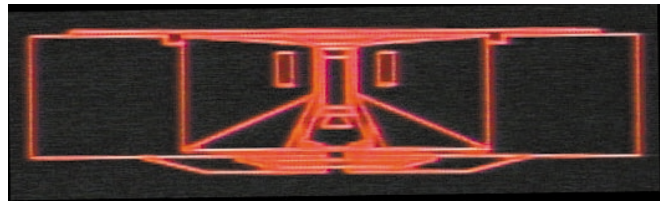
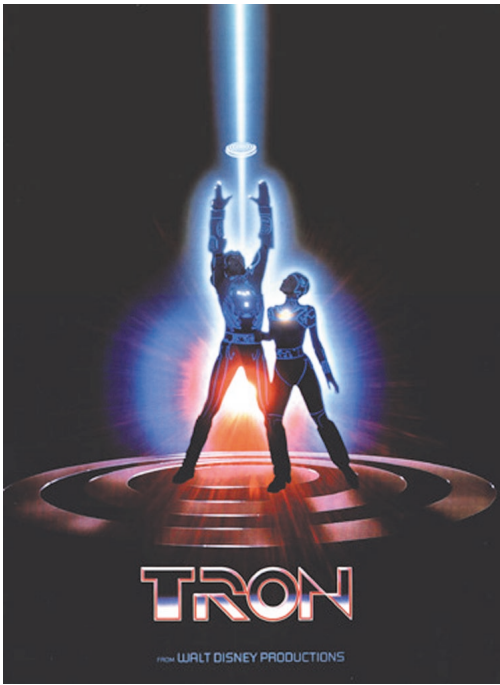

Front 5

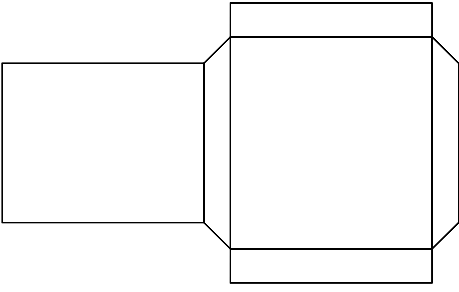

Front 6

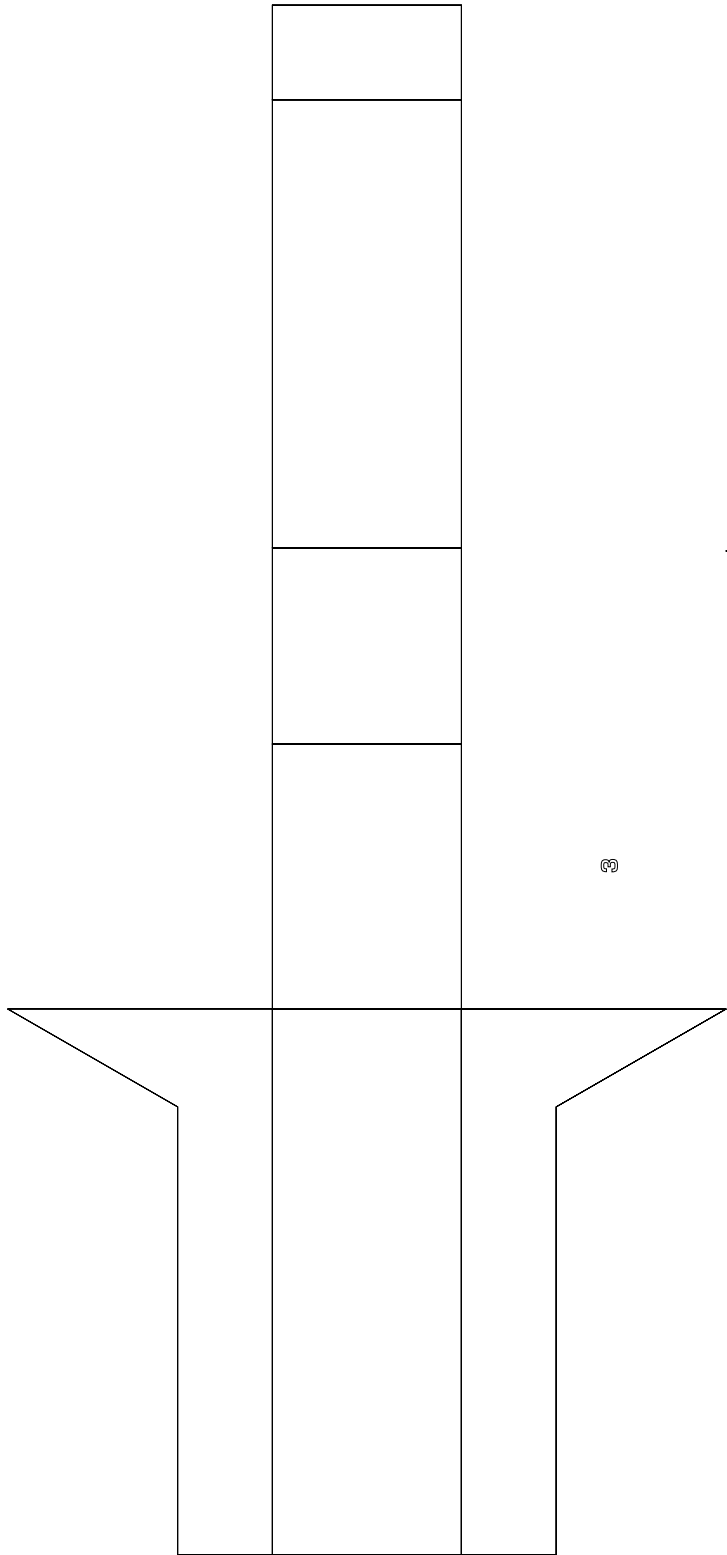
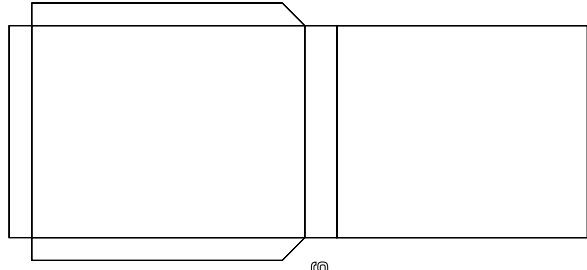

69

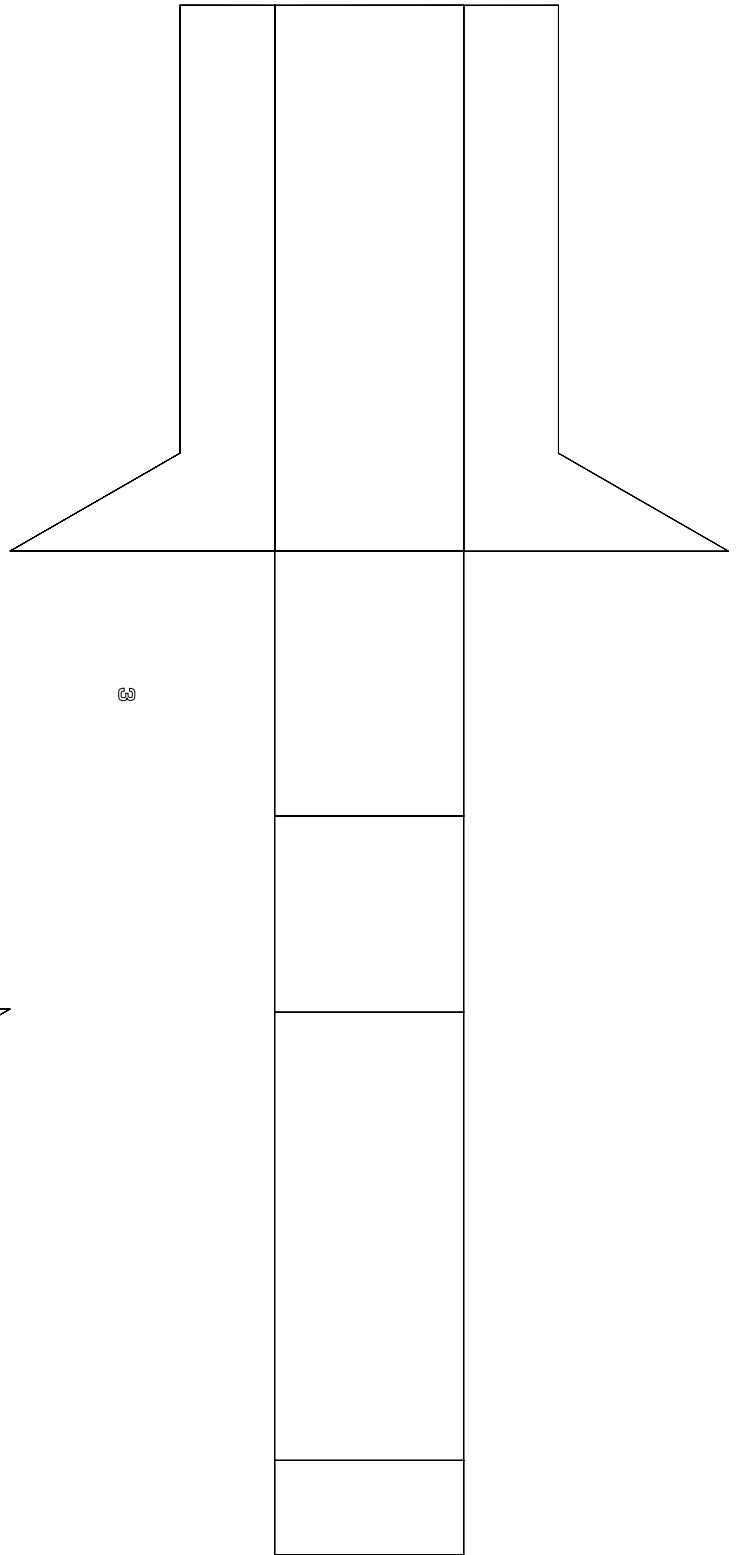

69

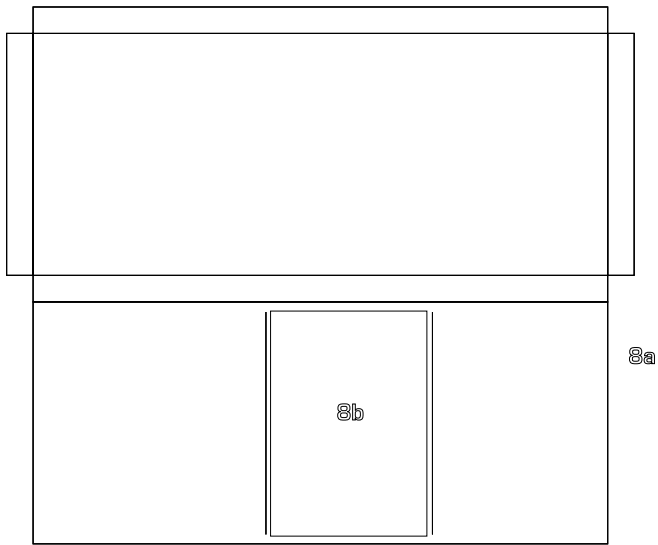

8a

8b

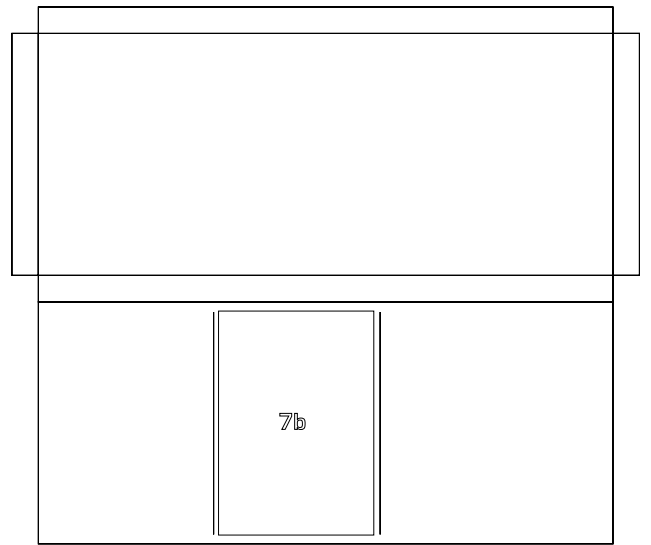

7a

7b

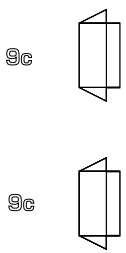

9c

9c

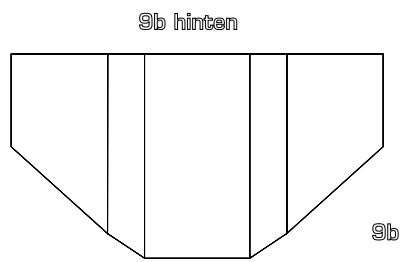

9b hinten

9

9b

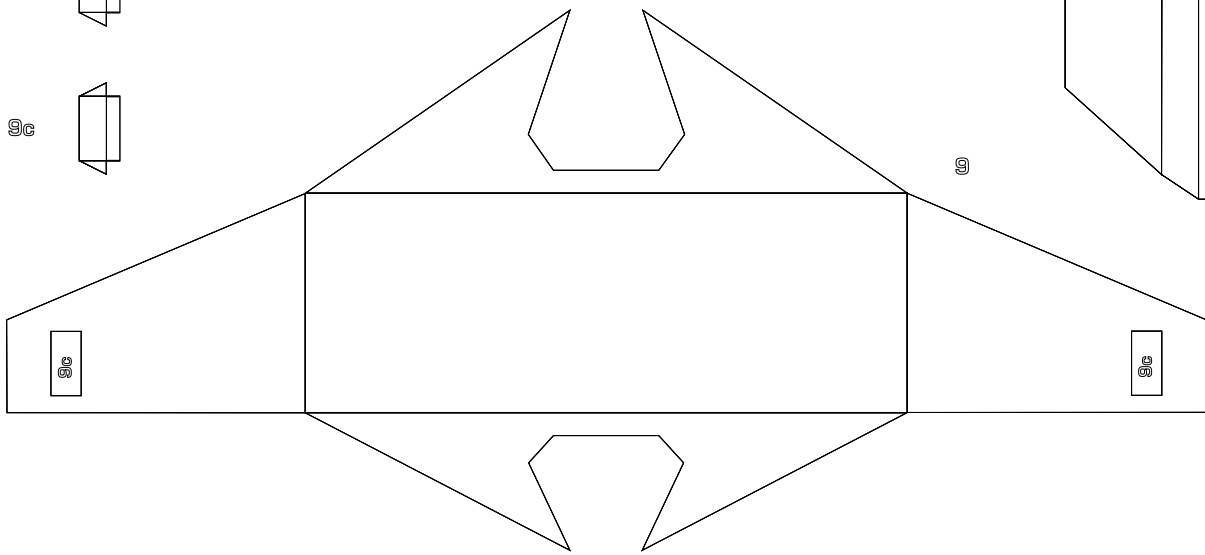

9c = ausschneiden und Teil 9c von Innen einkleben

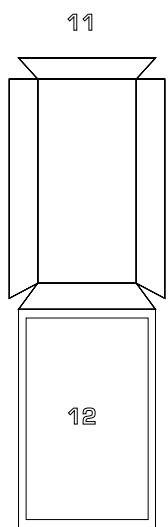

11

12

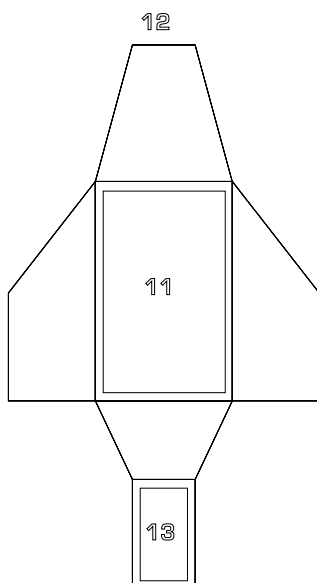

12

11

13

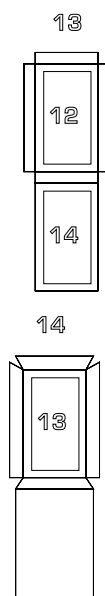

13

12

14

14

13

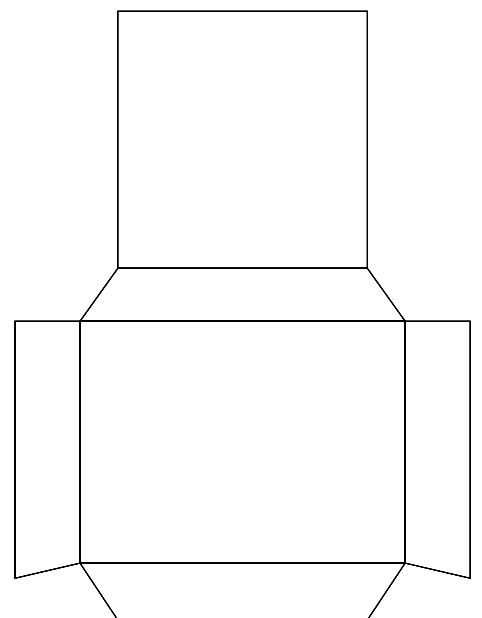

10

